



KUKiTiN G2 Max

USER MANUAL

EN



KuKirin G2 Max SCOOTER USER MANUAL

KuKirin G2 Max Scooter User Manual



Please read the manual before using the product--The warranty card is included.

CATALOG

1. MODEL&SPARE PARTS	2
2. FUNCTION DESCRIPTION	3
3. SAFETY INSTRUCTION	4-7
4. PRODUCTS DISPLAY	6-8
5. PRODUCTS ASSEMBLY	9
6. HEAD STEM TELESCOPIC	10
7. EXPAND STEPS	11
8. FOLDING STEPS	12
9. RECHARGING	13
10. TRANSFER	13
11. SEAT ASSEMBLY INSALLATION STEPS	14
12. SEAT FOLDING STEPS	15
13. SEAT EXPAND STEPS	16
14. C CONTROL SYSTEM STRUCTURE	17
15. OPERATING INSTRUCTIONS	18
16. RIDING INSTRUCTION	19
17. BATTERY&XRECHARGER	20
18. LCD DSPLY	21
19. STATUS INDICATION	22
20. MAINTENANCE	23
21. FAULT CODE	24
22. FAQ&SOLOTION	25
23. PARAMETER CONFIGURATION	26
24. W ARRANTY&SERVICE	27
25. WARRANTY CARD	28

PRODUCT CATEGORY



01

1.PRODUCT&SPARE PARTS

Body



parts

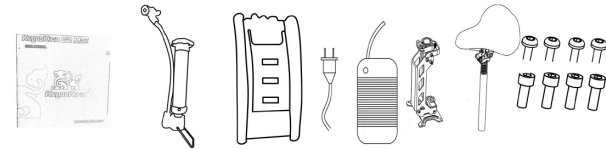

1.UserManual 2. Pump 3.Tool kits 4.Charger 5.Seat 6. Bolts

Please check it careful whether anything is missing or damaged.Please contact with us directly if so.

02

2.FUNCTION DESCRIPTION

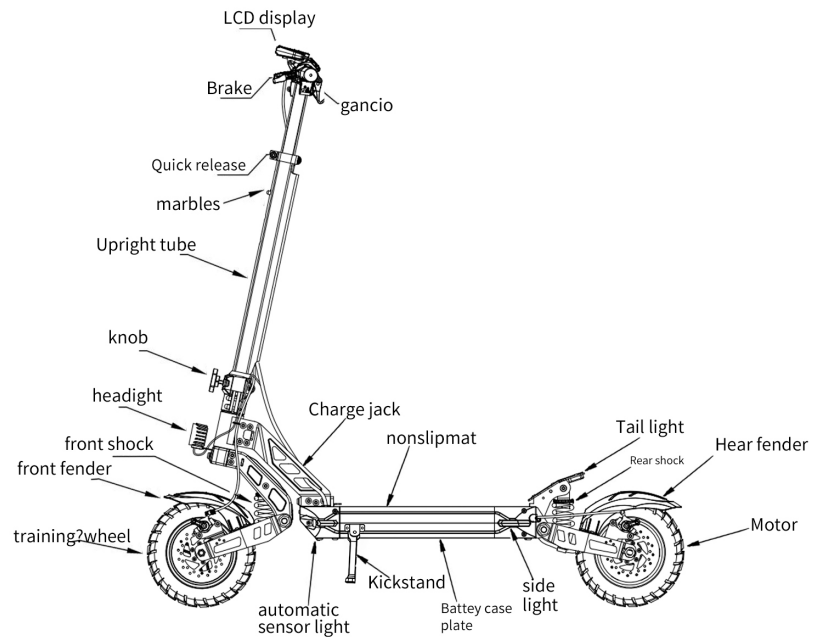

3.SAFETY INSTRUCTION

Note: Please read the following important security information carefully before use, and follow it.

1.Only allow one adult passenger riding.



2.Please wear protective equipmentbefore each ride.

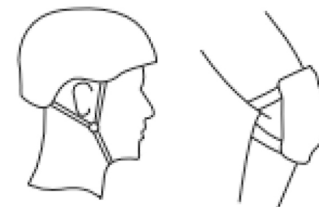

3.Don' t break the traffic rules.

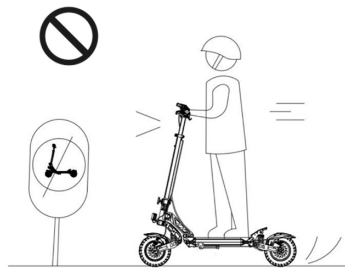

4.Please practice in the empty placefor more times, then going to riding on the road.

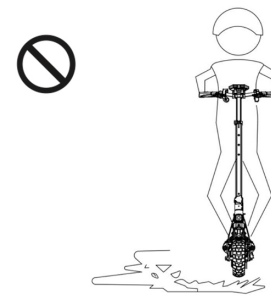

5. Don't riding with one hand or one foot, put your hands on the steering wheel and your feet on the deck.

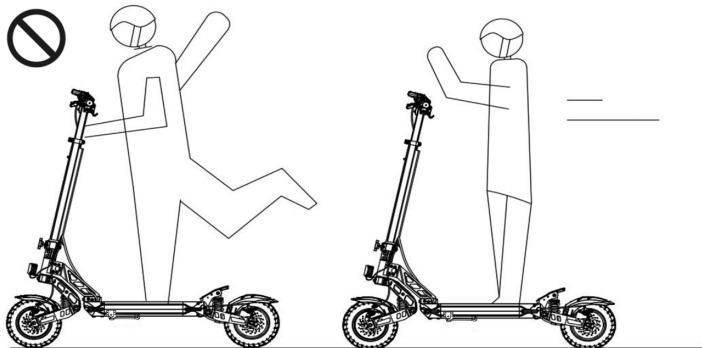

6. For your safety, the maximum speed limit for electric aircraft is 25km/h. Move over 15km/h and turn on the headlights.

7. Don't turn on the electric scooter when the temperature is under -5 °C



05

8. Please slow down or get off when moving on uneven surface.

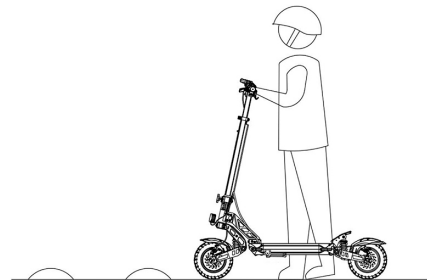

10. Don't ride in puddles with water depth more than 4cm.



9. Not riding on slippery surfaces.

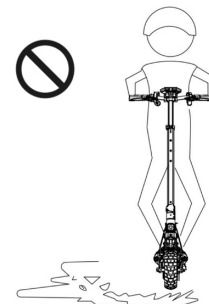

11. Don't ride in bad weather, such as rain or snow.

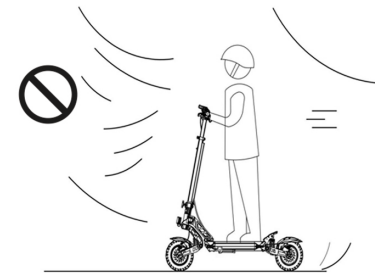

06

12. Please do not exceed the max allowable load specified by the manufacturer and specify in this user manual.

13. Do not use electric scooter when the ambient temperature is too low or too high. Keep electric locomotive away from flammable substances and open fire sources.

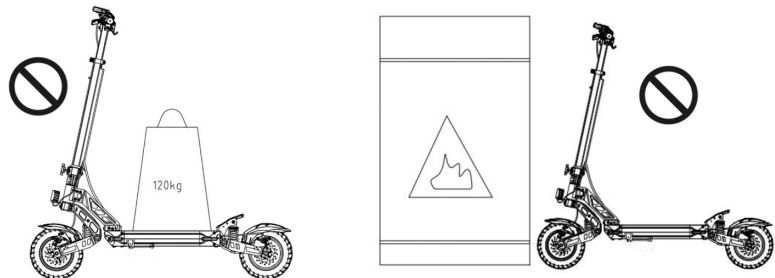

14. Try to ride the E-scooter on a flat surface.

15. PLEASE OBSERVE THE ROAD TRAFFIC RULES AND SIGNS. WHEN RIDING ON THE ROAD, KEEP THE RIGHT DIRECTION.

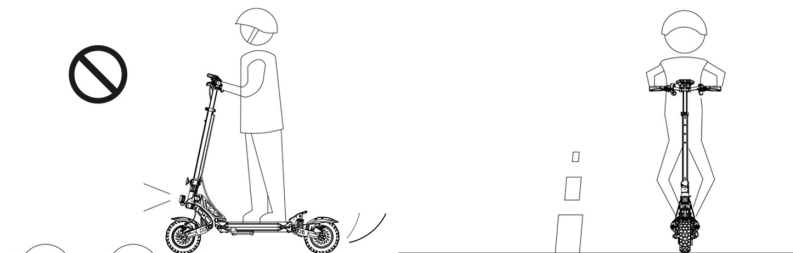

4. PRODUCTS DISPLAY



product opening status

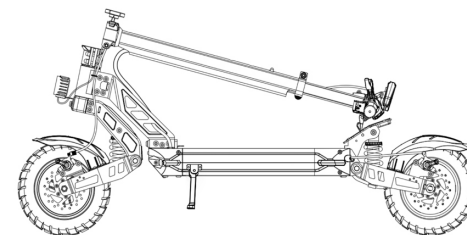

Product folded status

5. PRODUCT ASSEMBLY

1.Pull the scooter opening and then pull the kickstand out .Fixed thefolding switch.

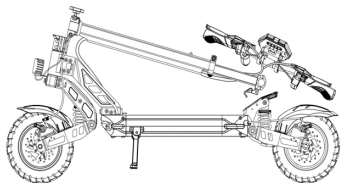

3.Plug in connector.Slide the stem on to the front fork. Be careful to pinch wire.



2.Take the main wire of the T-bar and the head stem.

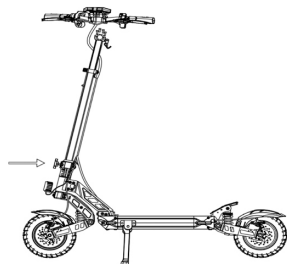

4.Use the toolkit to tight the screws,then check whether it is ok for the power on/off.



09

6.EXTEND-RETRACT FOR THE T-BAR

The telescopic gear of the front pole is divided into 3 gears, respectively low gear, middle gear and high gear.

Firstly,Loosen the quick release, then take one hand to press the ball and at thesame time, press the T-bar down with the other hand.The height from low to highor high to low is adjusted in this way. Then lock the quick release in the end.

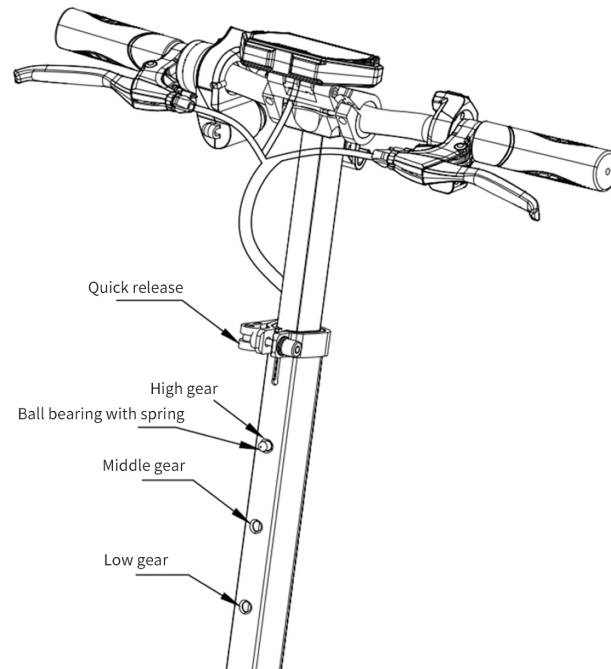

10

7. EXPAND STEPS

1. One hand press the clip, another one pull the upright tube up

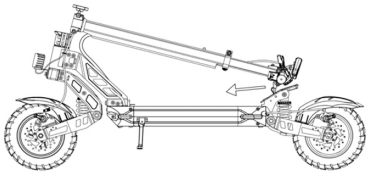

2. Pull the T-bar up.

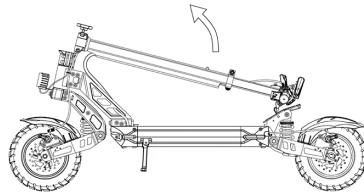

3. Pull the folding clip up after took the T-bar up.

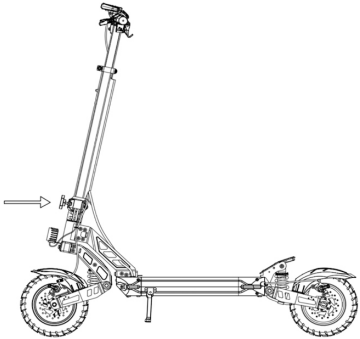

4. Lock the folding clip.



8. FOLDING STEPS

Note: For your safety, please folding the E-scooter with the power off.

1. Pull the safety catch upwards.

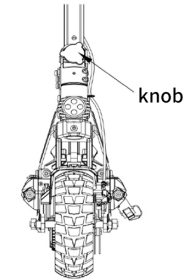

3. Puts down the front of the E-scooter



2. Pull the folding buckle outwards.



4. Take the lever hook into the hook card slot.

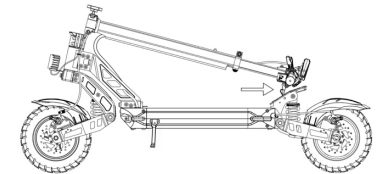

9. RECHARGING

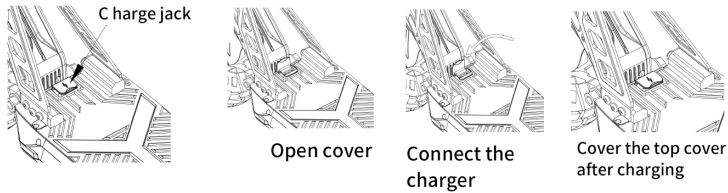

1. Open the waterproof plug of the charging port, then insert the charger plug into the charging port.
2. Put the charging plug into the power supply.
3. When the light is red which

10. TRANSFER

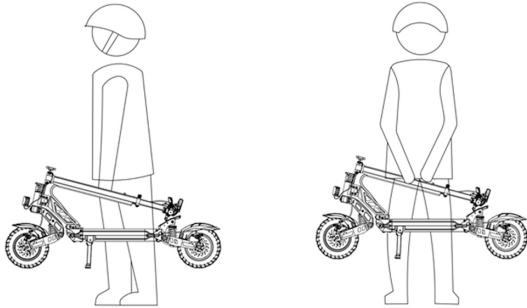

11. OPTIONAL SEAT ASSEMBLY INSTALLATION STEPS

1. Secure the seat bracket to the battery box pedal with 4 screws.

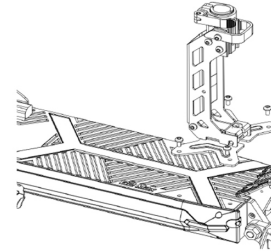

3. When the seat is ready to be removed and loosened, insert the seat into the corresponding card slot.

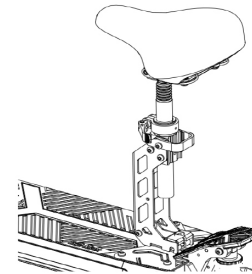

2. After the 4 screws are locked, loosen the seat for quick disassembly.

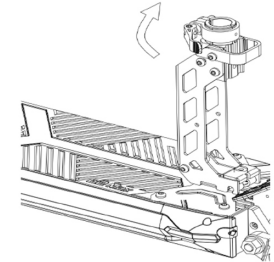

4. When the seat is in place, turn it to remove it quickly and lock it.

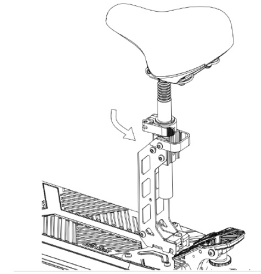

12. SEAT FOLDING STEPS

1. Release the seat and recline it in the direction of arrow as shown



2. When the seat is ready to be removed and recline, press the seat axle on the side.



3. When the seat axle is pressed to the bottom, place one hand on the seat bracket and slowly recline the seat

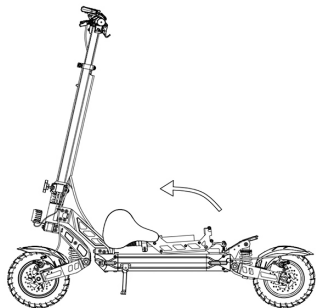

15

13. FOLDING STEPS

1. Press down the seat axle while raising the seat bracket.

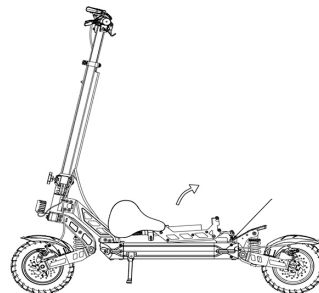

3. Shake the seat bracket to make sure the seat axle is stuck in the slot.



2. When the seat bracket is fully upright, release the seat axle so that the seat axle is stuck into the card slot.



4. When the seat axle is confirmed to be stuck into the slot, lift the seat up and lock it.



16

14.CONTROL SYSTEM STRUCTURE

1.Handle bar 2 Left brake handle 3.T-bar 4.LCD display 5.Right brake handle
6.Headlight button 7.Electric lock 8.Gear switch button

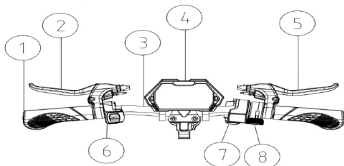

- 1.Insert the key and turn it to the right to switch on the power.
- 2.Long press to turn on/off the E-scooter.
- 3.Press 1 time in a short time,switch to different gear, default level 4. After startup, press the function switch button three times to enter the menu setting interface.

function switch button three times to enter the menu setting interface.

P1: km/mile Select Settings, default km

P2: Voltage level setting: 36V/48/52/60V /72V

P4: Number of tachometer magnetic poles: range: 1- 100, default: 30

P5: Cruise options: 0 indicates no cruise and 1 indicates cruise

P6: zero start, non-zero start Settings, 0: zero start; 1: non-zero startup

P7: Speed limit stting: range 0-100 percent speed limit

A parameter setting interface, such as P1, if P1 does not need to be modified, press the button once to switch to P2.

15.OPERATING INSTRUCTIONS

1.POWER BUTTON

Take the key to the right to turn on the power, then take it to the left to closed the power.

2.GEAR SETTING

Click the button on the throttle to switch gears, 1st gear(ECO 2nd gear(D),3rd gear(S)

3.SPEED CONTROL MODE

Non-zero starting: The throttle system will be working after the speed $\geq 3\text{km/h}$. Then press the throttle lever smoothly, the speed switch from 1 to 25km/h.

4. BRAKE CONTROL

Take your left hand to hold the brake handle, the harder you hold, the faster it braked.It will be the fastest braking, if you hold the right brake handle in the same time.

5.LED LIGHT POWER BUTTON

With the power on, push the light button forward to open the headlights,side lights and the tail.lamp.Push the light button back to closed the lights all.

6. CRUISE CONTROL

If you need to use this function, please refer to **GE Max** (function description). When the cruise control function is turned on, when the vehicle reaches the set speed, the cruise control function will automatically open the set speed. When cruise control is turned on, release the thumb accelerator and the scooter will automatically move forward at a constant speed. If you need to cancel the cruise control, pull the left hand brake handle, start the electronic brake, if you want to stop the cruise control function, please refer to **GE Max** (function description)

7.ZERO STARTING MODE

Put one foot on the deck and the other one on the road, then press the throttle lever downward smoothly. Then put your the other foot on the deck too after go aheadfor a distance.Then please riding with the speed from 1km/h to 50km/h for each ride.

16. RIDING INSTRUCTIONS

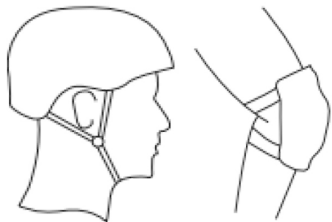

PREPARATION

- 1 Choose an open place for riding.
2. Please expand the E-scooter follow the expand steps and wear protective equipments before each ride.

1. Turn the key to the right to turn on the power.
2. One foot stand on the deck, the other one on road.

3 With the scooter sliding, please take your the other foot on the deck too. Meanwhile, press the throttle thumb shifter harder and harder with your right thumb, the speed will be faster and faster.

4. In Emergency, take your hands hold the brake handles harder, the scooter stopped faster and smoothly.

- 5 .Normally, take your left hand to hold the brake handle, the scooter will be power off and nbraked in a short time.

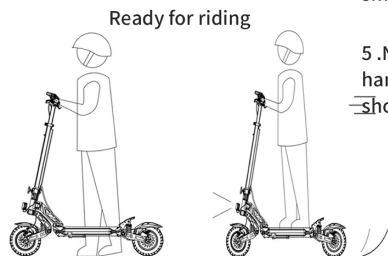

Tips: in order to be safely, the **G2 Max** model use the non-zero start function. It means that the throttle system is working after the scooter sliding for a distance, if you select that function.

17. BATTERY & RECHARGER

Each, **G2 Max** is provided with a lithium battery and charging device. Each E-scooter and spare part with its own number. Failure can result from the failure of the battery or other manufacturer's charging device or other type of charging device. It is out of warranty if the battery or recharger damaged caused thereby.

BATTERY



EQUIPPED LITHIUM BATTERY CAN BE RECHARGED AT LEAST 800 G2 Max TIMES, AND IT CAN BE USED FOR MORE THAN 1000 TIMES IN NORMAL USE. THE LITHIUM BATTERY MAY BE DANGEROUS WHEN CHARGING. PLEASE CHARGE IT OUTDOORS.

BATTERY RECHARGER



The charging device is equipped with an automatic circuit breaker system when the battery is fully charged. The charging time is 7-8 hours unless the battery is damaged due to improper charging. If the battery is not charged, contact the service center. If the battery is damaged by other abnormal reason, it is out of our warranty, please note.

18.LCD DISPLAY

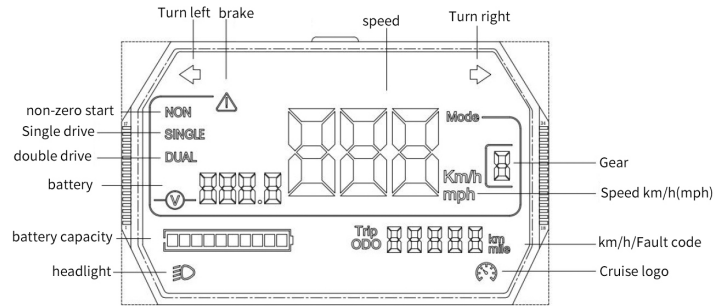

19.HEADLAMP

HEADLAMP STATUS INDICATOR:

OPEN	CLOSED
Headlights on and ready for use	The headlights are off

INDICATOR PRESIDENT:

Head gear	Second gear	Third gear
1st transport enable(ECO)	2nd transport enable(D)	3rd transport enable(S)

20.KEEP IN STORAGE

LUBRICATING OIL

Special grease is required every 6 months for the location of electric aircraft. Check if the electric scooter is faulty. Check every 3 months and tighten the bolts if necessary.

BATTERY

Turn off the power when charging or not in use. When not in use for a long time, keep the electric scooter in a safe place and do cover the battery charge electric scooters at least once every 3 months.

KEEP IN STORAGE

Do not store the electric scooter in the sun, keep it clean.

21.FAULT CODE

Error alert

E-001: MOTOR HULL FAULT

E-002: THROTTLE FAULT

E-003: CONTROLLER FAULT

E-005: BATTERY UNDERVOLTAGE FAULT

E-006: INSTRUMENT RECEPTION FAULT

E-007: INSTRUMENT TRANSMISSION FAULT

22. FAQ&Solution

Following as below if there is any problem :

01 BLACK display

Possible cause: long time in direct sunshine.

Possible solution: leave the electric scooter in the dark for a while.

02 The value on the display does:

not show the actual reading Possible cause: incorrect parameter setting

Possible solution: reset options.

03 The display is opaque or shows

Possible cause: poor contact connection or battery not charged

Possible solution: restart the electric vehicle or contact the service center.

04 Complete diagnosis

A. Power on

B. Check the power through the display screen

C: The right & left brakes are in place or not

D: All jacks and connection holes are properly connect

Please contact the seller, if it is still not working correct as above steps.

23. PARAMETER CONFIGURATION

Brand	KuKirin G2 Max Electric scooter	
Item No.	KuKirin G2 Max	
Size	Folded	1260x605x580mm
	Expanded	1260x605x1300mm
Main Parameter	Max speed	≤ 55KM/H
	Distance of full	≤ 80KM (based on the condition, slope, body weight, habits of riding, etc)
	Max slope	About 30°
	Tyre	10 inch rubber tyre
	damping system	front+rear spring
	Waterproof level	IP54
	Brake system	electric+disc brake
	LCD display	Headlight, cruise, brake, steering, gear, range indicator, steering, gear, range indicator,
Recharge data	Light system	LED high light
	Input voltage	100-240V
	Lithium battery	48V20AH
	Time of charging	About 7-8 hours
Max loading	Max loading	120KG
Weight	N.W	About 31KG

24. WARRANTY&SERVICE

This product since you buy in the warranty period, in the normal use of the situation after we confirm the quality of the failure and damage, we will be free of charge for you to repair, replace or return. The warranty period starts from the first purchase and is subject to the date of invoice receipt.

The warranty does not apply to failure or damage caused by:

1. Misuse, abuse or improper transportation, maintenance Or storage, such as using, strage or maintenance under improper temperature, humidity or other improper environmrnt condition.
2. Force majeure, accidents and other uncontrollable causes ;
3. Repair or separate by others who are not authorized by our company;
4. Use in a man ner that violates the product instructions;
5. The accumulated mileage of the car body has exceeded 2,000 kilometers. Normal wear and tear or aging during the use of the product is not covered by the warranty. If the original identification label of the product is changed or damaged, this warranty will be void

Warranty content	Warranty period
Controller assembly and central control instrument, motor	Half year
Lithium battery pack and protection plate, charger	Half year
Frame assembly, front body, rear hub, brake assembly, folding assembly, body bar, front fork, control cable	One year
Brake system, thumb accelerator	One year

Tips: These parts not covered by warranty: tire ,headlight assembly, instrument cover, handlebar ,tail lamp, kickstand, charge jack etc.

25. WARRANTY CARD

Please fill in the following information completely and clearly when repairing the product.

Buyer information	Name		Email	
	Address			
	TEL			
Model information	ModelName		Sales date	
	Item No.		Invoice No.	
Seller information	Name		TEL	
	Address		Zip code	